

 **WS10**

Displacement sensor with
measurement length up to
2,000 mm



- Protection class IP65
- Aluminum housing
- Optional with magnetic absolute encoder

Product versions

   Analog output, SSI output

 Analog output with magnetic encoder

  Analog output with magnetic encoder,
programmable

 Digital output SSI with magnetic encoder

 Digital output CAN Bus with magnetic
encoder

 Incremental encoder output



WS10 - Cable Extension Position Sensor
Version with analog output, SSI output

Specifications

		Order options	
Measurement range	100 / 125 / 375 / 500 / 750 / 1000 / 1250 mm	1	100 / 125 / 375 / 500 / 750 / 1000 / 1250
Resolution	Analog: quasi infinite		
Output	Potentiometer 1 kΩ Voltage 0 ... 10 V Current 4 ... 20 mA, 2 wire Current 4 ... 20 mA, 3 wire Current output, programmable Voltage output, programmable Signal conditioner SSI 12 bit Signal conditioner SSI 14 bit Signal conditioner SSI 16 bit	2	R1K 10V 420A 420T PMUI PMUV ADSI ADSI14 ADSI16
Linearity	±0.10% f.s. (standard) ±0.05% f.s. (optional)	3	L10 L05
Sensing device	Precision potentiometer		
Material	Aluminum measuring cable: stainless steel		
Protection class	IP65 (with mating connector only)		
Cable fixing	M4 cable fixing Cable clip	4	M4 SB0
Connection	Connector M12, 8 pin	5	M12
Temperature range	-20 ... +85 °C		
Weight	approx. 550 g		
EMC	DIN EN 61326-1:2013		

Order code

WS10 – **1** – **2** – **3** – **4** – **5**

Order example: WS10 – 1250 – 10V – L10 – M4 – M12

Accessories:

Connector cable (see page 34)

Cable forces typical at = 20 °C	Measurement range	Maximum pull-out force	Minimum pull-in force
	[mm]	[N]	[N]
	100	4,7	3,0
	125	4,6	2,4
	375	7,4	3,9
	500	5,5	2,8
	750	7,6	3,8
	1000	5,3	2,9
	1250	4,6	2,4

Dimensions

Measurement range 100 ... 1250 mm, analog output, SSI output

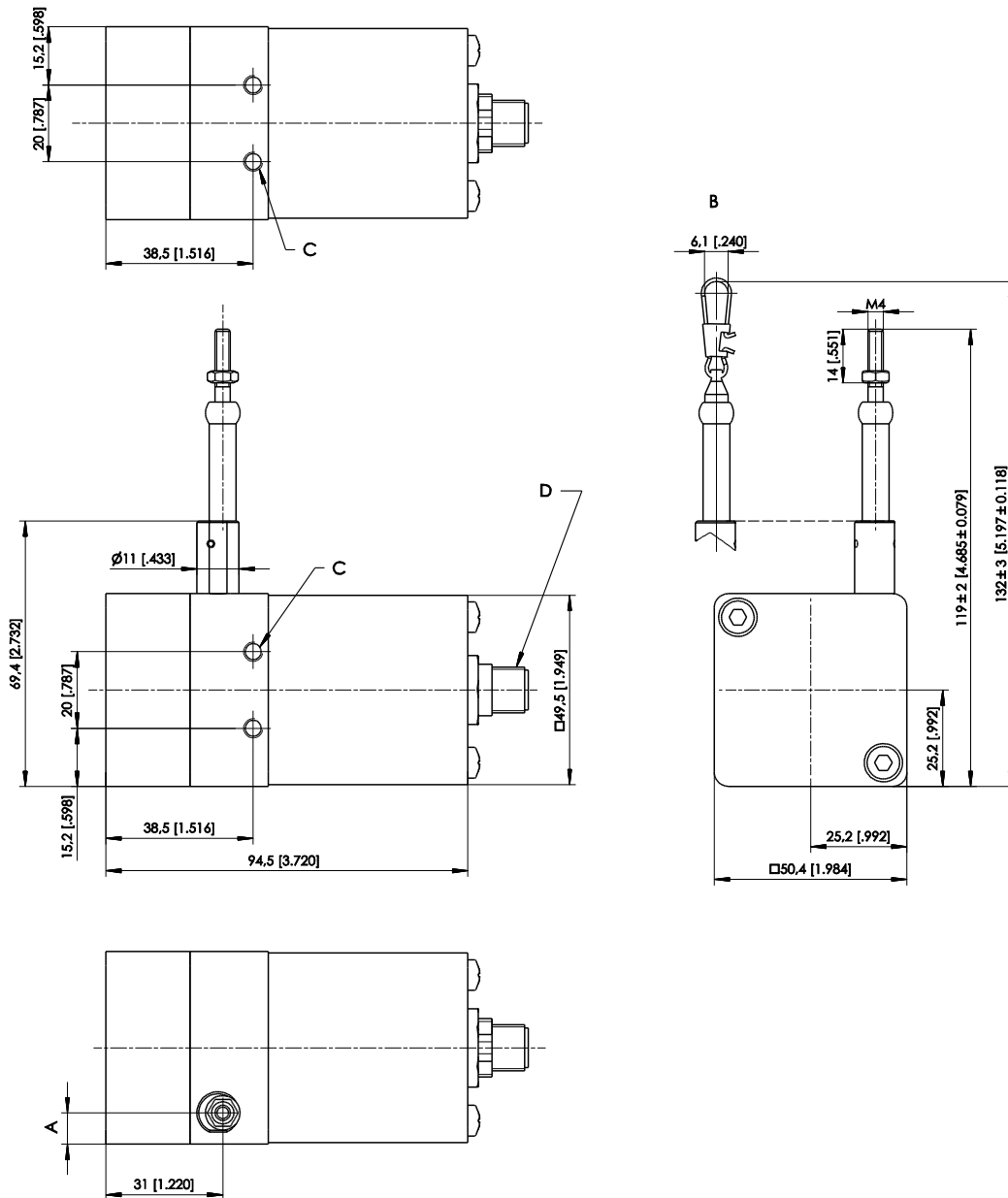

Dimensions in mm	Measurement range	A
	375; 750	12.7
	100; 125; 500; 1000; 1250	8.2

- B – Option SB0
- C – M5 - 8 [.315] deep
- D – Connector M12

Dimensions in mm [inch]
Dimensions informative only.
For guaranteed dimensions consult factory.



WS10 - Cable Extension Position Sensor

Version with analog output with magnetic encoder

Specifications

		Order options
Measurement range	250 / 375 / 500 / 750 / 1000 / 1250 / 1500 / 2000 mm	1 250 / 375 / 500 / 750 / 1000 / 1250 / 1500 / 2000
Resolution	<0.002% f.s.	
Output	Voltage 0.5 ... 10 V Voltage 0.5 ... 4.5 V Current 4 ... 20 mA, 3 wire	2 U2 U8 I1
Signal characteristics	Increasing signal (e.g. 4 ... 20 mA) Decreasing signal (e.g. 20 ... 4 mA)	3 A D
Linearity	±0.10% f.s. (standard) ±0.05% f.s. (optional)	4 L10 L05
Sensing device	Magnetic absolute encoder	
Material	Aluminum measuring cable: stainless steel	
Protection class	IP65 (with mating connector only)	
Cable fixing	M4 cable fixing Cable clip	5 M4 SB0
Connection	Connector M12, 5 pin (standard) Connector M12, 8 pin (optional)	6 M12A5 M12A8
Shock	DIN EN 60068-2-27:2010, 100 g/11 ms, 100 shocks	
Vibration	DIN EN 60068-2-6:2008, 20 g 10 Hz-2 kHz, 10 cycles	
Temperature range	-20 ... +85 °C	
Weight	approx. 550 g	
EMC	DIN EN 61326-1:2013	

Order code

WS10	-	1	-	2	-	3	-	4	-	5	-	6
------	---	----------	---	----------	---	----------	---	----------	---	----------	---	----------

Order example: WS10 – 1250 – U2 – A – L10 – M4 – M12A5

Accessories:

Connector cable (see page 32)



WS10 - Cable Extension Position Sensor

Version with analog output with magnetic encoder, programmable

Specifications

		Order options
Measurement range	250 / 375 / 500 / 750 / 1000 / 1250 / 1500 / 2000 mm	1 250 / 375 / 500 / 750 / 1000 / 1250 / 1500 / 2000
Resolution	<0.002% f.s.	
Output	Voltage 0.5 ... 10 V, programmable Voltage 0.5 ... 4.5 V, programmable Current 4 ... 20 mA, 3 wire, programmable	2 U2/PMU U8/PMU I1/PMU
Signal characteristics	Increasing signal (e.g. 4 ... 20 mA) Decreasing signal (e.g. 20 ... 4 mA)	3 A D
Linearity	±0.10% f.s. (standard) ±0.05% f.s. (optional)	4 L10 L05
Sensing device	Magnetic absolute encoder	
Material	Aluminum measuring cable: stainless steel	
Protection class	IP65 (with mating connector only)	
Cable fixing	M4 cable fixing Cable clip	5 M4 SB0
Connection	Connector M12, 5 pin	6 M12A5
Shock	DIN EN 60068-2-27:2010, 100 g/11 ms, 100 shocks	
Vibration	DIN EN 60068-2-6:2008, 20 g 10 Hz-2 kHz, 10 cycles	
Temperature range	-20 ... +85 °C	
Weight	approx. 550 g	
EMC	DIN EN 61326-1:2013	

Order code

WS10	-	1	-	2	-	3	-	4	-	5	-	6
------	---	----------	---	----------	---	----------	---	----------	---	----------	---	----------

Order example: WS10 – 1250 – U2/PMU – A – L10 – M4 – M12A5

Accessories:

Connector cable (see page 33)



WS10 - Cable Extension Position Sensor

Version with digital output SSI with magnetic encoder

Specifications

			Order options
Measurement range	250 / 375 / 500 / 750 / 1000 / 1250 / 1500 / 2000 mm	1	250 / 375 / 500 / 750 / 1000 / 1250 / 1500 / 2000
Resolution	10 µm 50 µm 100 µm	2	10 50 100
Output	SSI synchronous serial interface	3	MSSI
Linearity	±0.10% f.s. (standard) ±0.05% f.s. (optional)	4	L10 L05
Sensing device	Magnetic absolute encoder		
Material	Aluminum measuring cable: stainless steel		
Protection class	IP65 (with mating connector only)		
Cable fixing	M4 cable fixing Cable clip	5	M4 SB0
Connection	Connector M12, 8 pin	6	M12A8
Shock	DIN EN 60068-2-27:2010, 100 g/11 ms, 100 shocks		
Vibration	DIN EN 60068-2-6:2008, 20 g 10 Hz-2 kHz, 10 cycles		
Temperature range	-20 ... +85 °C		
Weight	approx. 550 g		
EMC	DIN EN 61326-1:2013		

Order code

WS10	-	1	-	2	-	3	-	4	-	5	-	6
------	---	----------	---	----------	---	----------	---	----------	---	----------	---	----------

Order example: WS10 – 1250 – 50 – MSSI – L10 – M4 – M12A8

Accessories:

Connector cable (see page 34)



WS10 - Cable Extension Position Sensor

Version with digital output CAN Bus with magnetic encoder

Specifications

		Order options
Measurement range	100 / 125 / 375 / 500 / 750 / 1000 / 1250 / 2000 mm	1 100 / 125 / 375 / 500 / 750 / 1000 / 1250 / 2000
Resolution	setting via CAN Bus	
Output	CANopen CAN SAE J1939	2 MCANOP MCANJ1939
Linearity	±0.10% f.s. (standard) ±0.05% f.s. (optional)	3 L10 L05
Sensing device	Magnetic absolute encoder	
Material	Aluminum measuring cable: stainless steel	
Protection class	IP65 (with mating connector only)	
Cable fixing	M4 cable fixing Cable clip	4 M4 SB0
Connection	Connector M12, 5 pin	5 M12/CAN
Shock	DIN EN 60068-2-27:2010, 100 g/11 ms, 100 shocks	
Vibration	DIN EN 60068-2-6:2008, 20 g 10 Hz-2 kHz, 10 cycles	
Temperature range	-20 ... +85 °C	
Weight	approx. 550 g	
EMC	DIN EN 61326-1:2013	

Order code

WS10	-	1	-	2	-	3	-	4	-	5
------	---	----------	---	----------	---	----------	---	----------	---	----------

Order example: WS10 – 1250 – MCANOP – L10 – M4 – M12/CAN

Accessories:

Connector cable (see page 35)

Cable forces typical at = 20 °C	Measurement range	Maximum pull-out force	Minimum pull-in force
	[mm]	[N]	[N]
	250	4.6	2.4
	375	7.4	3.9
	500	5.5	2.8
	750	7.6	3.8
	1000	5.3	2.9
	1250	4.6	2.4
	1500	3.8	2.4
	2000	3.8	2.4

Dimensions

Measurement range 250 ... 1250 mm, magnetic encoder output

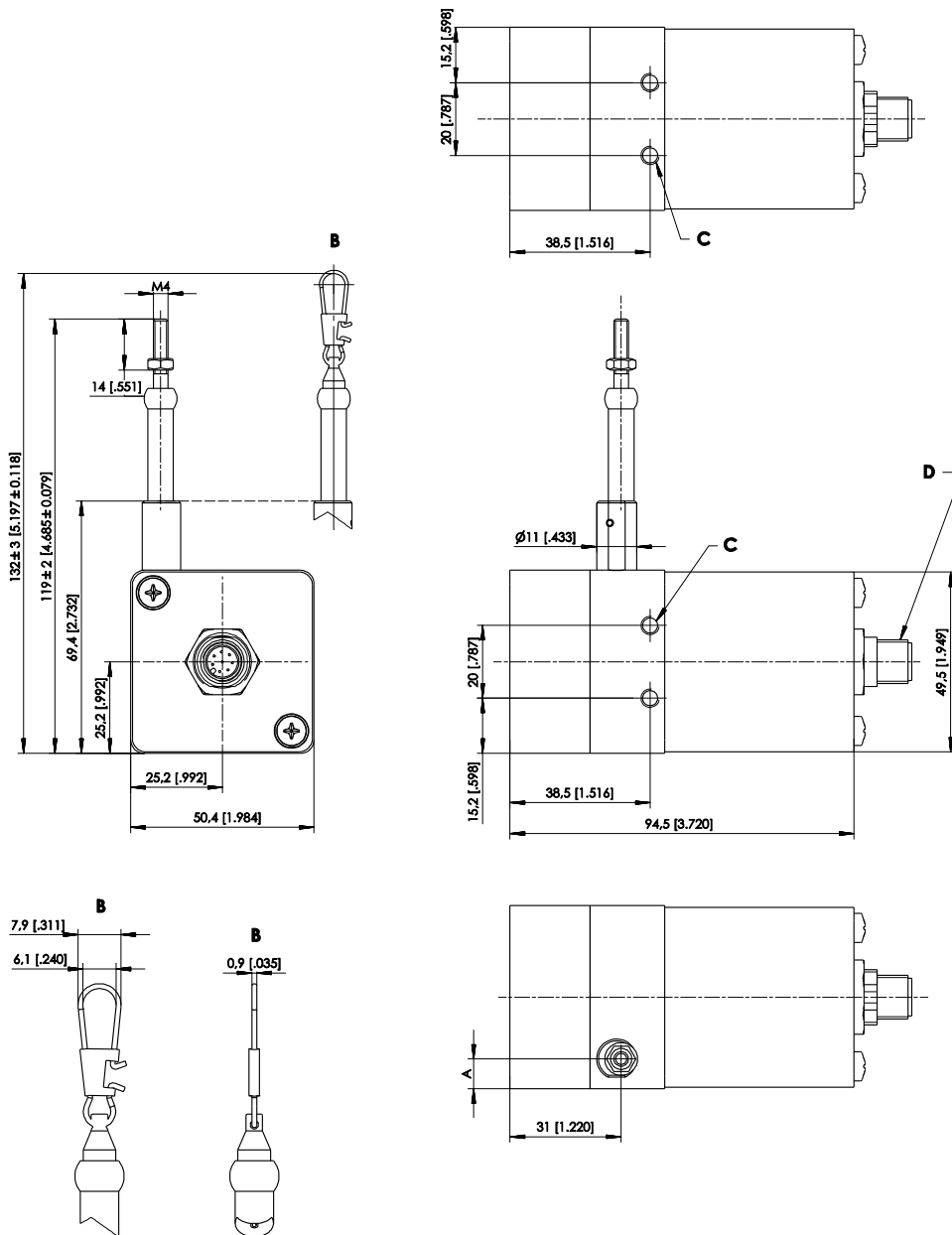

Dimensions in mm	Measurement range	A
	250	16.7
	375; 750	12.7
	500; 1000; 1250	8.2

- B – Option SB0
- C – Mounting drillings 4 x M5 - 8 [.315] deep
- D – Connector M12

Dimensions in mm [inch]
Dimensions informative only.
For guaranteed dimensions consult factory.

Measurement range 1500 ... 2000 mm, magnetic encoder output

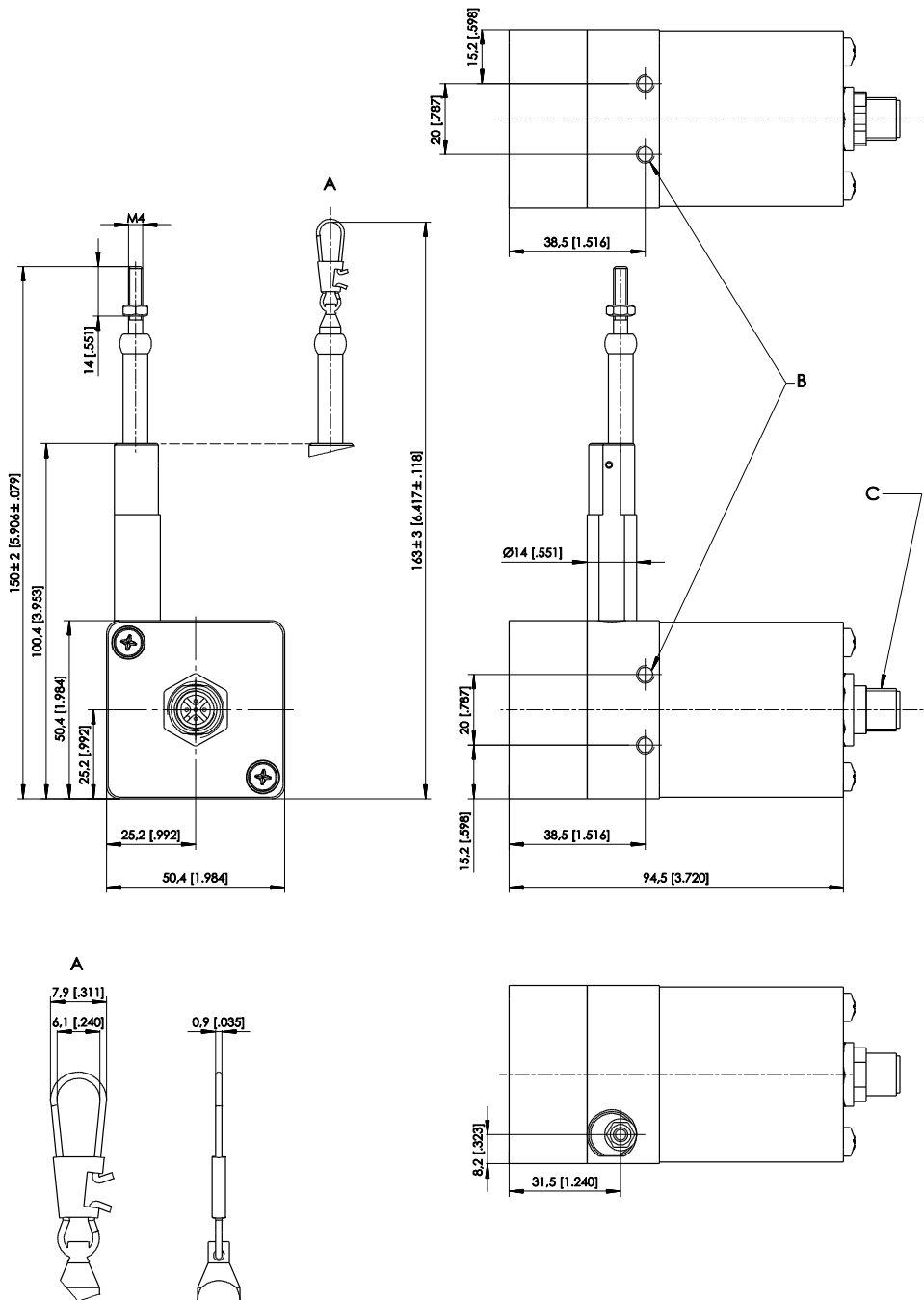

- A – Option SB0
- B – M5 - 8 [.315] deep
- C – Connector M12

Dimensions in mm [inch]
Dimensions informative only.
For guaranteed dimensions consult factory.

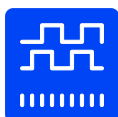

WS10 - Cable Extension Position Sensor
Version with incremental encoder output

Specifications

		Order options
Measurement range	1250 mm	1 1250
Resolution	10 pulses/mm or 40 edges/mm 25 pulses/mm or 100 edges/mm (other numbers of pulses on request)	2 10 25
Output	Incremental output 5 ... 30 V Incremental encoder TTL compatible Incremental encoder HTL compatible	3 PP530 IE41L IE41HI
Linearity	±0.05% f.s.	
Sensing device	Incremental encoder	
Material	Aluminum measuring cable: stainless steel	
Protection class	IP65 (with mating connector only)	
Cable fixing	M4 cable fixing Cable clip	4 M4 SB0
Connection	Connector M12, 8 pin	5 M12
Temperature range	-20 ... +85 °C	
Weight	approx. 550 g	
EMC	DIN EN 61326-1:2013	

Order code

WS10 – **1** – **2** – **3** – **4** – **5**

Order example: WS10 – 1250 – 10 – PP530 – M4 – M12

Accessories:

Connector cable (see page 34)

Cable forces Typical at = 20 °C	Measurement range	Maximum pull-out force	Minimum pull-in force
	[mm]	[N]	[N]
	1250	5,8	3,0

Dimensions

Measurement range 1250 mm, incremental encoder output

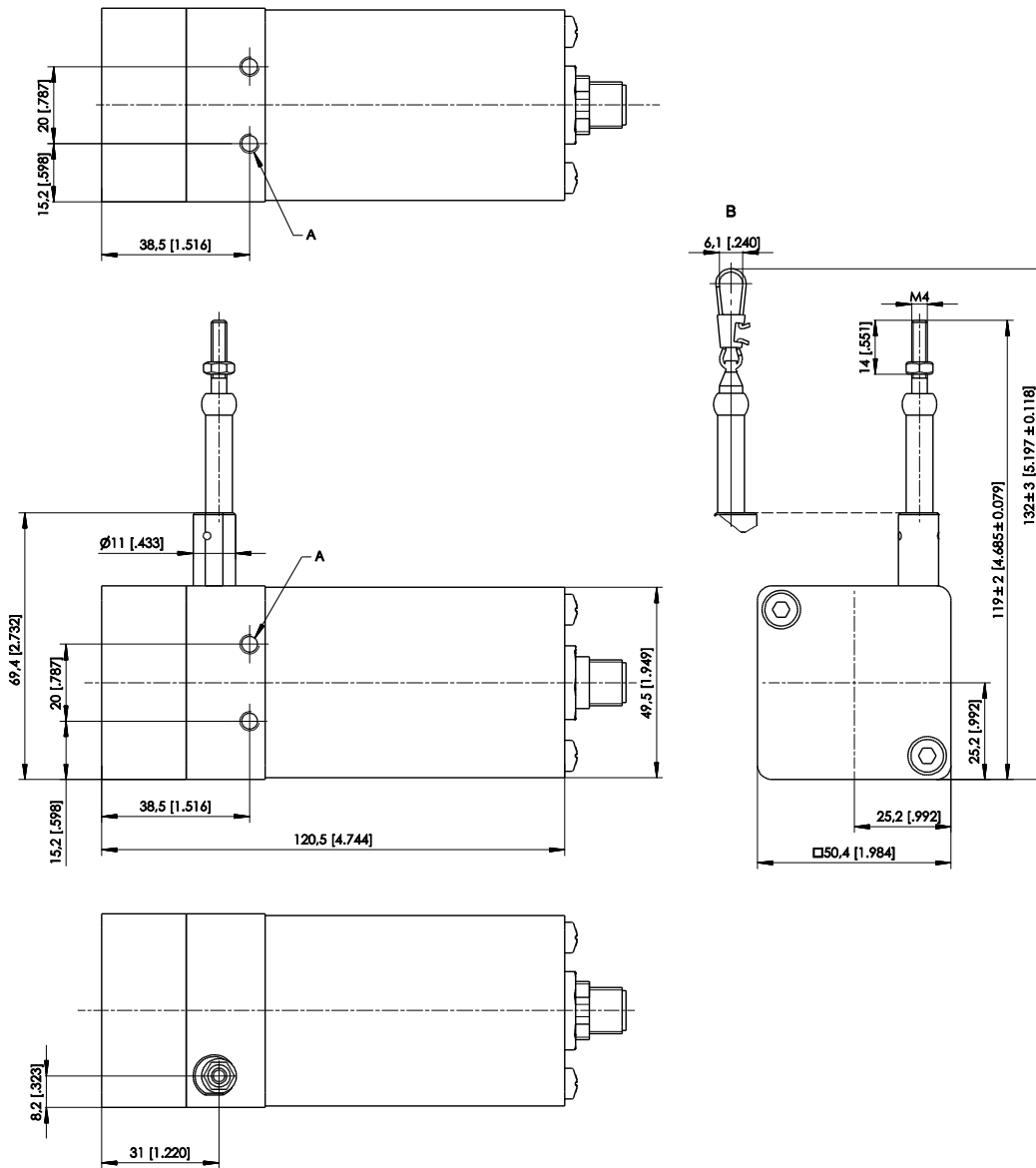

A – M5 - 8 [.315] deep
B – Option SB0

Dimensions in mm [inch]
Dimensions informative only.
For guaranteed dimensions consult factory.

Output specifications

Analog outputs

Voltage divider

R1K Potentiometer 	Excitation voltage	32 V DC max. at 1 kΩ (max. power 1 W)
	Potentiometer impedance	1 kΩ ±10 %
	Thermal coefficient	±25 x 10 ⁻⁶ / °C f.s.
	Sensitivity	Depends on the measuring range, individual sensitivity of the sensor is specified on the label
	Voltage divider utilization range	approx. 3 % ... approx. 97 %
	Operating temperature	Refer to output specification
	EMC	DIN EN 61326-1:2013

NOTICE

The potentiometer must be connected as a voltage divider!

The following processing circuit has to be implemented according to the circuit scheme in the Appendix (see „Output information“)

Electrical current flow impact on the wiper causes linearity errors and shortens the lifetime of the potentiometer

- The metal wiper of the potentiometer must be protected against current load

Additional information:

https://www.asm-sensor.com/en/downloads.html?file=files/asmTheme/pdf/ws_poti_technote_en.pdf

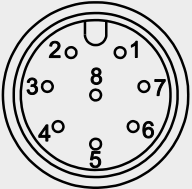
Signal wiring	Signal	Connector pin no.	Cable color
Connector M12, 8 pin  View to the sensor connector	Poti +	1	white
	Poti GND	2	brown
	Poti slider	3	green
	-	4	yellow
	-	5	grey
	-	6	pink
	-	7	blue
	-	8	red

10V Voltage output 	Excitation voltage	18 ... 27 V DC non stabilized
	Excitation current	20 mA max.
	Output voltage	0 ... 10 V DC
	Output current	2 mA max.
	Output load	> 5 kΩ
	Stability (temperature)	±50 x 10 ⁻⁶ / °C f.s.
	Protection	Reverse polarity, short circuit
	Output noise	0.5 mV _{RMS}
	Operating temperature	Refer to output specification
	EMC	DIN EN 61326-1:2013

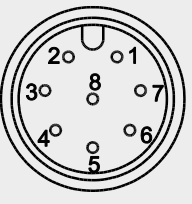
Signal wiring	Output signals	Connector pin no.	Cable color
Connector M12, 8 pin  View to the soldering side of mating connector	Excitation +	1	white
	Excitation GND*	2	brown
	Signal +	3	green
	Signal GND*	4	yellow
	Not connected	5	grey
	Not connected	6	pink
	Not connected	7	blue
	Not connected	8	red

*: internally connected

420A Current output (2 wire) 	Excitation voltage	18 ... 27 V DC non stabilized, measured at the sensor terminals
	Excitation current	35 mA max.
	Output current	4 ... 20 mA equivalent for 0 ... 100 % range
	Stability (temperature)	$\pm 100 \times 10^{-6}$ / °C f.s.
	Protection	Reversed polarity, short circuit
	Output noise	0.5 mV _{eff}
	Operating temperature	Refer to output specification
	EMC	DIN EN 61326-1:2013

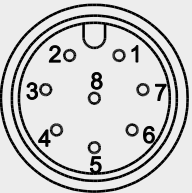
Signal wiring	Output signals	Connector pin no.	Cable color
Connector M12, 8 pin  View to the sensor connector	Signal +	1	white
	Signal -	2	brown
	Not connected	3	green
	Not connected	4	yellow
	Not connected	5	grey
	Not connected	6	pink
	Not connected	7	blue
	Not connected	8	red

420T Current output (3 wire) 	Excitation voltage	18 ... 27 V DC non stabilized
	Excitation current	40 mA max.
	Load resistor	350 Ω max.
	Output current	4 ... 20 mA equivalent for 0 ... 100 % range
	Stability (temperature)	±50 x 10 ⁻⁶ / °C f.s.
	Protection	Reverse polarity, short circuit
	Output noise	0.5 mV _{RMS}
	Operating temperature	Refer to output specification
	EMC	DIN EN 61326-1:2013

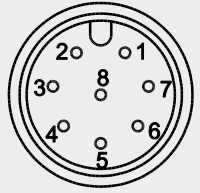
Signal wiring	Output signals	Connector pin no.	Cable color
Connector M12, 8 pin  View to soldering side of mating connector	Excitation +	1	white
	Excitation GND*	2	brown
	Signal +	3	green
	Signal GND*	4	yellow
	Not connected	5	grey
	Not connected	6	pink
	Not connected	7	blue
	Not connected	8	red

*: internally connected

PMUV Voltage output programmable	Excitation voltage	18 ... 27 V DC
	Excitation current	50 mA max.
PMUI Current output programmable	Voltage output PMUV	0 ... 10 V
	Output current	10 mA max.
	Output load	1 kΩ min.
	Current output PMUI	4 ... 20 mA (3 wire)
	Working resistance	500 Ω max.
	Scaling	
	Activation of offset and gain adjust	Connect with excitation GND (0 V)
	Scalable range	90 % max. f.s.
	Stability (temperature)	±50 x 10 ⁻⁶ / °C f.s.
	Operating temperature	Refer to output specification
	Protection	Reversed polarity, short circuit
	EMC	DIN EN 61326-1:2013

PMUV / PMUI

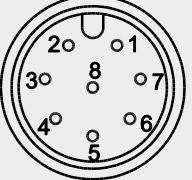
Signal wiring Connector M12, 8 pin	Output signals	Connector pin no.	Cable color
	Excitation +	1	white
	Excitation GND*	2	brown
	Signal +	3	green
	Signal GND*	4	yellow
	Not connected	5	grey
	Not connected	6	pink
	ZERO	7	blue
	END	8	red

View to soldering side of mating connector

*: internally connected

PMUI2

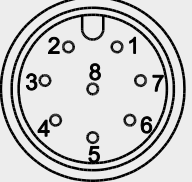
Signal wiring Connector M12, 8 pin	Output signals	Connector pin no.	Cable color
	Excitation +	1	white
	Excitation GND*	2	brown
	Not connected	3	green
	Not connected	4	yellow
	Signal +	5	grey
	Signal GND*	6	pink
	ZERO	7	blue
	END	8	red

View to soldering side of mating connector

*: internally connected

Outputs .../PMUV, PMUI, PMUI2

Programming of the start and end value by the customer

Teach-In of start and end value for the outputs PMUV, PMUV and PMUI2 is provided by two binary signals ZERO and END. At the start position connect signal ZERO for a short period to GND via push button. At the end position connect signal END for a short period to GND. The scaling range will be stored non-volatile. To reset the sensor to factory default both signals ZERO and END must be connected to ground while powering up the sensor.

Digital Interfaces

ADSI A/D converted synchronous serial 	Excitation voltage	11 ... 27 V DC
	Excitation current	200 mA max.
	Interface	EIA RS422, RS485, short-circuit proof
	Clock frequency	70 ... 500 kHz
	Code	Gray-Code, continuous progression
	Delay between pulse trains	30 µs min.
	Resolution	ADSI16: 16 bit (65536 counts) f.s. ADSI14: 14 bit (16384 counts) f.s. ADSI: 12 bit (4096 counts) f.s.
	Stability (temperature)	±50 x 10 ⁻⁶ / °C f.s.
	Operating temperature	-20 ... +85 °C
	EMC	DIN EN 61326-1:2013

Data format

(train of 26 pulses)

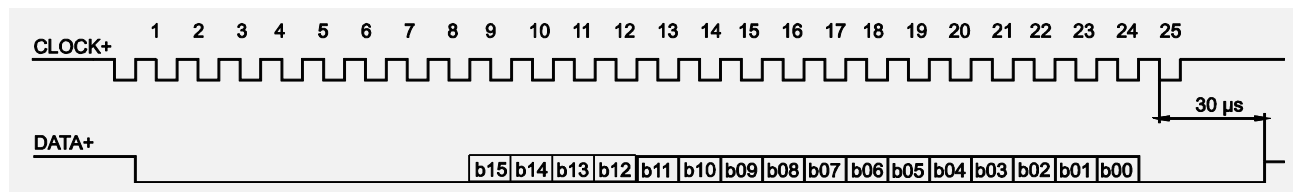

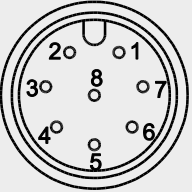

Transmission rate	Cable length	Baud rate	Note:
	< 50 m	< 300 kHz	Extension of the cable length will reduce the maximum transmission rate.
	< 100 m	< 100 kHz	

Signal wiring	Output signals	Connector pin no.	Cable color
Connector M12, 8 pin  View to soldering side of mating connector	Excitation +	1	white
	Excitation GND (0 V)	2	brown
	CLOCK	3	green
	$\overline{\text{CLOCK}}$	4	yellow
	DATA	5	grey
	$\overline{\text{DATA}}$	6	pink
	Not connected	7	blue
	Not connected	8	red

Magnetic encoder, analog output

U2 Voltage output 0.5 ... 10 V 	Excitation voltage	8 ... 36 V DC
	Excitation current	20 mA typical at 24 V DC 38 mA typical at 12 V DC max. 50 mA
	Output voltage	0.5 ... 10 V DC
	Output current	2 mA max.
	Measuring rate	1 kHz standard
	Stability (temperature)	$\pm 50 \times 10^{-6}$ / °C f.s. (typical)
	Protection	Reverse polarity, short circuit
	Operating temperature	See specification of the respective sensor
	EMC	DIN EN 61326-1:2013

U8 Voltage output 0.5 ... 4.5 V 	Excitation voltage	8 ... 36 V DC
	Excitation current	17 mA typical at 24 V DC 32 mA typical at 12 V DC 50 mA max.
	Output voltage	0.5 ... 4.5 V DC
	Output current	2 mA max.
	Measuring rate	1 kHz standard
	Stability (temperature)	$\pm 50 \times 10^{-6}$ / °C f.s. (typical)
	Protection	Reverse polarity, short circuit
	Operating temperature	See specification of the respective sensor
	EMC	DIN EN 61326-1:2013

I1 Current output 4 ... 20 mA, 3 wires 	Excitation voltage	8 ... 36 V DC
	Excitation current	typical 36 mA at 24 V DC typical 70 mA at 12 V DC 120 mA max.
	Load R_L	500 Ω max.
	Output current	4 ... 20 mA
	Measuring rate	1 kHz standard
	Stability (temperature)	$\pm 50 \times 10^{-6}$ / °C f.s. (typical)
	Protection	Reverse polarity, short circuit
	Operating temperature	See specification of the respective sensor
	EMC	DIN EN 61326-1:2013

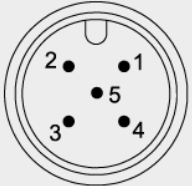
Signal wiring	Output signals	Connector pin no.	Cable color
Connector M12, 5 pin  View to the sensor connector	Excitation +	1	brown
	Signal	2	white
	GND	3	blue
	Do not connect!	4	black
	Do not connect!	5	(grey)

Magnetic encoder, analog output, programmable

U2/PMU Voltage output 0.5 ... 10 V 	Excitation voltage	8 ... 36 V DC
	Excitation current	20 mA typical at 24 V DC 38 mA typical at 12 V DC max. 50 mA
	Output voltage	0,5 ... 10 V DC
	Output current	2 mA max.
	Measuring rate	1 kHz standard
	Stability (temperature)	$\pm 50 \times 10^{-6}$ / °C f.s. (typical)
	Protection	Reverse polarity, short circuit
	Operating temperature	See specification of the respective sensor
	EMC	EN 61326-1:2013

U8/PMU Voltage output 0.5 ... 4.5 V 	Excitation voltage	8 ... 36 V DC
	Excitation current	17 mA typical at 24 V DC 32 mA typical at 12 V DC max. 50 mA
	Output voltage	0.5 ... 4.5 V DC
	Output current	2 mA max.
	Measuring rate	1 kHz standard
	Stabilität (Temperatur)	$\pm 50 \times 10^{-6}$ / °C f.s. (typical)
	Protection	Reverse polarity, short circuit
	Operating temperature	See specification of the respective sensor
	EMC	DIN EN 61326-1:2013

I1/PMU Current output 4 ... 20 mA, 3 wires 	Excitation voltage	8 ... 36 V DC
	Excitation current	typical 36 mA at 24 V DC typical 70 mA at 12 V DC max. 120 mA
	Load R _L	500 Ω max.
	Output current	4 ... 20 mA
	Measuring rate	1 kHz standard
	Stability (temperature)	$\pm 50 \times 10^{-6}$ / °C f.s. (typical)
	Protection	Reverse polarity, short circuit
	Operating temperature	See specification of the respective sensor
	EMC	DIN EN 61326-1:2013

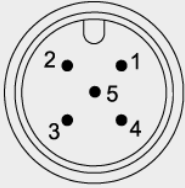
Signal wiring	Output signals	Connector pin no.	Cable color
Connector M12, 5 pin  View to the sensor connector	Excitation +	1	brown
	Signal	2	white
	GND	3	blue
	Do not connect!	4	black
	SPAN/ZERO	5	grey

Output .../PMU

Programming of the start and end value by the customer (programmable)

Teach-In of start and end value for the analog outputs U2/PMU, U8/PMU, I1/PMU is provided by a binary signal SPAN/ZERO. At the start position connect signal SPAN/ZERO for a period of 2 ... 3 seconds to GND via push button. At the end position connect signal SPAN/ZERO for a period of 5 ... 6 seconds to GND via a push button. The scaling range will be stored non-volatile.

To reset the sensor to factory default ZERO/END must be connected to ground while powering up the sensor for 2 ... 3 seconds.

Magnetic encoder, digital output

MSSI Synchronous serial SSI 	Interface	EIA RS-422
	Excitation voltage	8 ... 36 V DC
	Excitation current	19 mA typical at 24 V DC 35 mA typical at 12 V DC max. 80 mA
	Clock frequency	100 kHz ... 500 kHz
	Code	Gray-Code, continuous progression
	Delay between pulse trains (t_p)	30 μ s min.
	Stability (temperature)	$\pm 50 \times 10^{-6}$ / °C f.s. (typical)
	Operating temperature	See specification of the respective sensor
	Protection	Reverse polarity, short circuit
	EMC	DIN EN 61326-1:2013

Data format

(Train of 26 pulses)

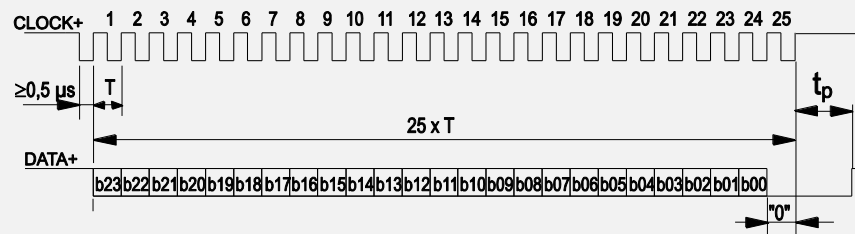

Transmission rate	Cable length	Baud rate	Note:
	50 m	100-400 kHz	Extension of the cable length will reduce the maximum transmission rate.
	100 m	100-300 kHz	

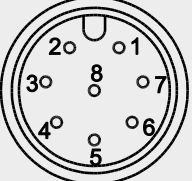
Signal wiring	Output signals	Connector pin no.	Cable color
Connector M12, 8 pin  View to the sensor connector	Excitation +	1	white
	Excitation GND	2	brown
	CLOCK	3	green
	$\overline{\text{CLOCK}}$	4	yellow
	DATA	5	grey
	$\overline{\text{DATA}}$	6	pink
	-	7	blue
	-	8	red

MCANOP CANopen 	CAN specification	ISO 11898, Basic and Full CAN 2.0 B
	Communication profile	CANopen CiA 301 V 4.02, Slave
	Encoder profile	Encoder CiA 406 V 3.2
	Error Control	Node Guarding, Heartbeat, Emergency Message
	Node ID	Adjustable via LSS or SDO, default: 127
	PDO	3 TxPDO, 0 RxPDO, no linking, static mapping
	PDO Modes	Event-/Time triggered, Remote-request, Sync cyclic/acyclic
	SDO	1 Server, 0 Client
	CAM	8 cams
	Certified	Yes
	Transmission rate	50 kBit bis 1 Mbit, adjustable via LSS or SDO, default: 125 kBit
	Bus connection	M12 connector, 5 pin
	Integrated bus terminating resistor	120Ω adjustable by the customer
	Bus, galvanic isolated	no

Specifications	Excitation voltage	8 ... 36 V DC
	Excitation current	20 mA typical at 24 V DC 40 mA typical at 12 V DC 80 mA max.
	Measuring rate	1 kHz (asynchronous)
	Stability (temperature)	$\pm 50 \times 10^{-6}/^{\circ}\text{C}$ f.s. (typical)
	Repeatability	1 LSB
	Operating temperature	See specification of the respective sensor
	Protection	Reverse polarity, short circuit
	Dielectric strength	1 kV (V AC, 50 Hz, 1 min.)
	EMC	EN 61326-1:2013

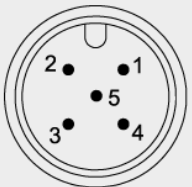
Signal wiring	Output signals	Connector pin no.	Cable color
Connector M12, 5 pin 	Shield	1	brown
	Excitation +	2	white
	GND	3	blue
	CAN-H	4	black
	CAN-L	5	grey

View to the sensor connector

MCANJ1939 SAE J1939 	CAN Specification	ISO 11898, Basic and Full CAN 2.0 B
	Transceiver	24V-compliant, not isolated
	Communication profile	SAE J1939
	Baud Rate	250 kbit/s
	Internal termination resistor	120 Ω adjustable by the customer
	Address	Default 247d, configurable

NAME Fields	Arbitrary address capable	1	Yes
	Industry group	0	Global
	Vehicle system	7Fh (127d)	Non specific
	Vehicle system instance	0	
	Function	FFh (255d)	Non specific
	Function instance	0	
	ECU instance	0	
	Manufacturer	145h (325d)	Manufacturer ID
	Identity number	0nnn	Serial number 21 bit

Parameter Group Numbers (PGN)	Configuration data	PGN EF00h	Proprietary-A (PDU1 peer-to-peer)
	Process data	PGN FFnnh	Proprietary-B (PDU2 broadcast); nn Group Extension (PS) configurable

Specifications	Excitation voltage	8 ... 36 V DC
	Excitation current	20 mA typical at 24 V DC 40 mA typical at 12 V DC max. 80 mA
	Measuring rate	1 kHz (asynchronous)
	Stability (temperature)	±50 x 10 ⁻⁶ /°C f.s. (typical)
	Repeatability	1 LSB
	Operating temperature	See specification of the respective sensor
	Protection	Reverse polarity, short circuit
	Dielectric strength	1 kV (V AC, 50 Hz, 1 min.)
	EMV	EN 61326-1:2013

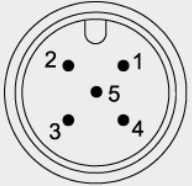
Signal wiring	Output signals	Connector pin no.	Cable color
Connector M12, 5 pin  View to the sensor connector	Shield	1	brown
	Excitation +	2	white
	GND	3	blue
	CAN-H	4	black
	CAN-L	5	grey

Incremental output

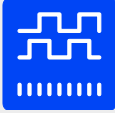
PP530 Incremental interface 	Excitation voltage	5 ... 30 V DC
	Excitation current	25 mA typ. (w/o load), 200 mA max.
	Output frequency	200 kHz max.
	Output	Linedriver, Push-Pull, CMOS, TTL and HTL compatible
	Output current	30 mA max.
	Output voltage	Depends on the excitation voltage
	Saturation voltage high/low	$I_a < 10 \text{ mA}, U_b 5 \text{ V}/24 \text{ V}: < 0,5 \text{ V}$ $I_a < 30 \text{ mA}, U_b 5 \text{ V}/24 \text{ V}: < 1 \text{ V}$
	Stability (temperature)	$\pm 20 \times 10^{-6} / ^\circ\text{C}$ f.s. (sensor mechanism)
	Operation temperature	-10 ... +70 °C
	Storage temperature	-30 ... +80 °C
	Transition time positive edge	< 200 ns
	Transition time negative edge	< 200 ns
	Protection	Reverse polarity, short circuit *)
	EMC	DIN EN 61326-1:2013

NOTICE

*) Line driver may get damaged in case of shorted output for unlimited time

- Prevent unused output signals (e.g. $\overline{A}/\overline{B}/\overline{Z}$) from unintentionally being shorted with each other or any other voltage like ground, excitation + or shield.
- Isolate and secure unused output wires.

Output signals

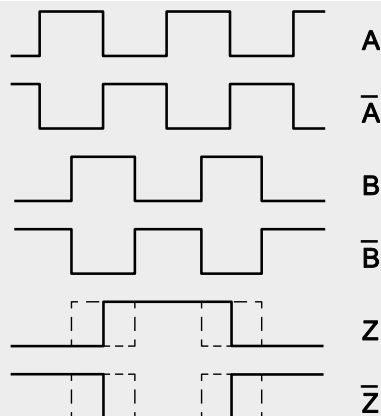

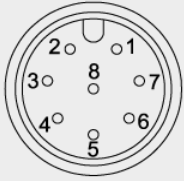
Signal wiring	Output signals	Connector pin no.	Cable color
Connector M12, 8 pin  View to soldering side of mating connector	Excitation +	1	white
	Excitation GND	2	brown
	Signal A	4	yellow
	Signal \bar{A}	6	pink
	Signal B (A + 90°)	3	green
	Signal \bar{B}	5	grey
	Signal Z (reference pulse)	7	blue
	Signal \bar{Z}	8	red

IE41LI and IE41HI Incremental interface	IE41LI	IE41HI	
	Excitation voltage	5 V DC ±10 %	10 ... 30 V DC
	Excitation current	150 mA max. (w/o load)	
	Output frequency	300 kHz max.	200 kHz max.
	Output	RS422	Push-pull antivalent
	Output current	±30 mA max.	30 mA
	Output voltage	Depending on the excitation voltage	
	Stability (temperature)	±20 x 10 ⁻⁶ / °C f.s. (sensor mechanism)	
	Operating temperature	-10 ... +70 °C	
	Protection against short circuit	One channel for 1 s	yes
	EMC	DIN EN 61326-1:2013	

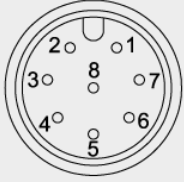
Signal wiring WS10 Connector M12, 8 pin	Output signals	Connector pin no.	Cable color
 <p>View to the sensor connector</p>	Excitation +	1	white
	Excitation GND	2	brown
	Signal A	4	yellow
	Signal \bar{A}	6	pink
	Signal B (A + 90°)	3	green
	Signal \bar{B}	5	grey
	Signal Z (reference pulse)	7	blue
	Signal \bar{Z}	8	red

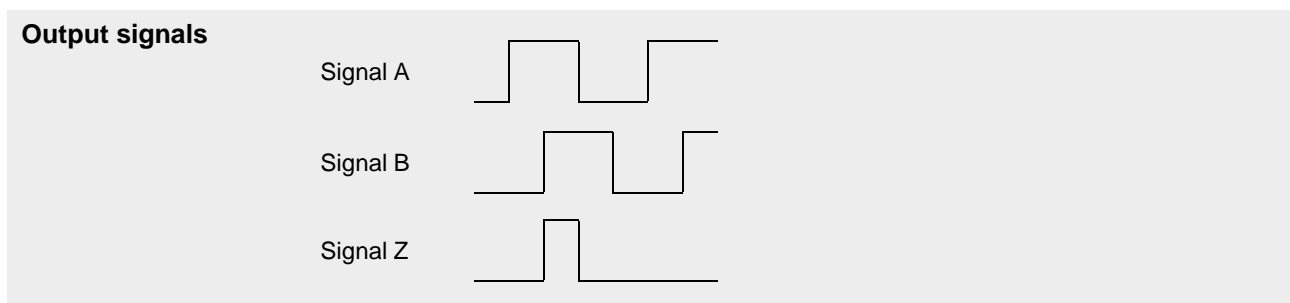

Accessories

Connector cable M12, 4 pin (angular coupling)

shielded connector
Suitable for 5-pin
sensor connectors

The 4-core screened cable is supplied with a mating 4-pin 90° M12 connector at one end and 4 wires at the other end. Available lengths are 2 m, 5 m and 10 m.
Wire: cross sectional area 0.34 mm²
Cable diameter: 5.6 ±0.2 mm

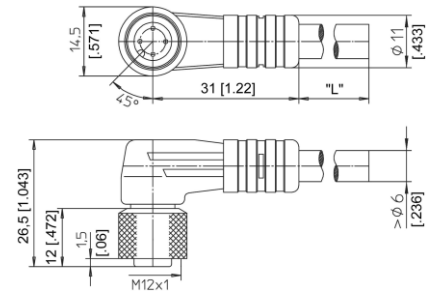

Order code

	KAB - xM - M12/4F/W - LITZE
IP69:	KAB - xM - M12/4F/W/69K - LITZE

xM = length in m

Connector cable M12, 4 pin (straight coupling)

shielded connector
Suitable for 5-pin
sensor connectors

The 4-core screened cable is supplied with a mating 4-pin M12 connector at one end and 4 wires at the other end. Available lengths are 2 m, 5 m and 10 m.
Wire: cross sectional area 0.34 mm²
Cable diameter: 5.6 ±0.2 mm

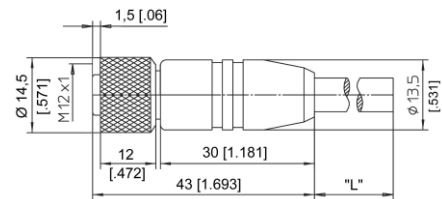

Order code

	KAB - xM - M12/4F/G - LITZE
IP69:	KAB - xM - M12/4F/G/69K - LITZE

xM = length in m

Signal wiring M12, 4 pin	Plug connection / cable color			
	1	2	3	4
	brown	white	blue	black

Applicable for cable carriers

Maximum movement speed	3 m/s
Maximum acceleration	5 m/s ²
Minimum bending radius	10 x cable diameter

Connector cable M12, 5 pin (angular coupling)

shielded connector

The 5-core screened cable is supplied with a mating 5-pin 90° M12 connector at one end and 4 wires at the other end. Available lengths are 2 m, 5 m and 10 m.

Wire: cross sectional area 0.34 mm²

Cable diameter: 5.6 ±0.2 mm

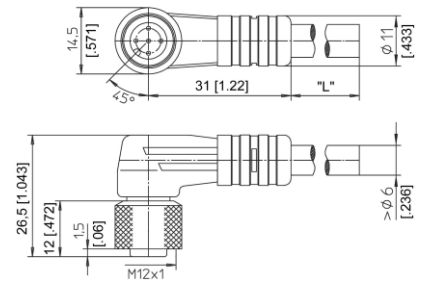

Order code

KAB - xM - M12/5F/W - LITZE

IP69: **KAB - xM - M12/5F/W/69K - LITZE**

xM = length in m

Connector cable M12, 5 pin (straight coupling)

shielded connector

The 5-core screened cable is supplied with a mating 5-pin M12 connector at one end and 4 wires at the other end. Available lengths are 2 m, 5 m and 10 m.

Wire: cross sectional area 0.34 mm²

Cable diameter: 5.6 ±0.2 mm

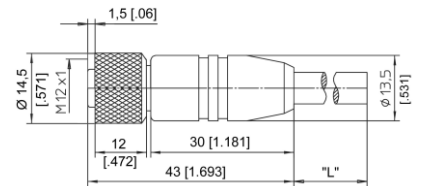

Order code

KAB - xM - M12/5F/G - LITZE

IP69: **KAB - xM - M12/5F/G/69K - LITZE**

xM = length in m

Signal wiring M12, 5 pin	Plug connection / Cable color				
	1	2	3	4	5
	brown	white	blue	black	grey

Applicable for cable carriers

Maximum movement speed	3 m/s
Maximum acceleration	5 m/s ²
Minimum bending radius	10 x cable diameter

Connector cable M12, 8 pin (angular coupling)

shielded connector

The 8-lead shielded cable is supplied with a mating 8-pin 90° M12 connector at one end and 8 wires at the other end. Available lengths are 2 m, 5 m and 10 m. Wire: cross sectional area 0.25 mm²
Cable diameter: 6.3 ±0.2 mm

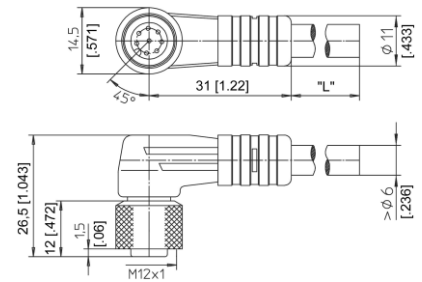

Order code

KAB - xM - M12/8F/W - LITZE

IP69: **KAB - xM - M12/8F/W/69K - LITZE**

xM = length in m

Connector cable M12, 8 pin (straight coupling)

shielded connector

The 8-lead shielded cable is supplied with a mating 8-pin M12 connector at one end and 8 wires at the other end. Available lengths are 2 m, 5 m and 10 m. Wire: cross sectional area 0.25 mm²
Cable diameter: 6.3 ±0.2 mm

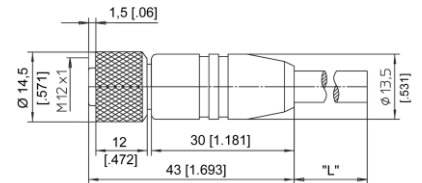

Order code

KAB - xM - M12/8F/G - LITZE

IP69: **KAB - xM - M12/8F/G/69K - LITZE**

xM = length in m

Signal wiring M12, 8 pin	Plug connection / cable color							
	1	2	3	4	5	6	7	8
	white	brown	green	yellow	grey	pink	blue	red

Applicable for cable carriers

Maximum movement speed	3 m/s
Maximum acceleration	5 m/s ²
Minimum bending radius	10 x cable diameter

Connector/bus cable M12, 5 pin CAN-Bus

The 5-lead shielded cable is supplied with a female 5 pin M12 connector at one end and a male 5 pin M12 connector at the other end.

Available lengths are 0.3 m, 2 m, 5 and 10 m.

Cable diameter: 6.7 ±0.2 mm

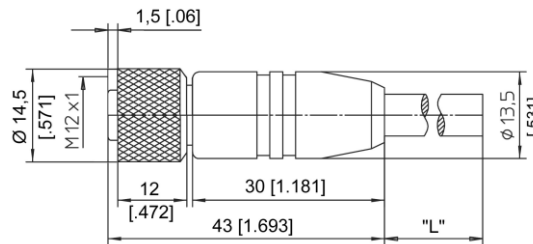

Order code

KAB - xM - M12/5F/G - M12/5M/G - CAN

IP69: **KAB - xM - M12/5F/G/69K - M12/5M/G/69K - CAN**

xM = length in m

T-connector for bus cable M12, 5 pin CAN-Bus

Order code

KAB - TCONN - M12/5M - 2M12/5F - CAN



Terminating resistor M12, 5 pin CAN-Bus

Order code

KAB - RTERM - M12/5M/G - CAN



Applicable for cable carriers

Maximum movement speed	3 m/s
Maximum acceleration	5 m/s ²
Minimum bending radius	10 x cable diameter

Plug-in connector M12, 8 pin (straight coupling)

Order code:

CONN-M12-8F-G

Cable diameter
max. 6 ... 8 mm

